

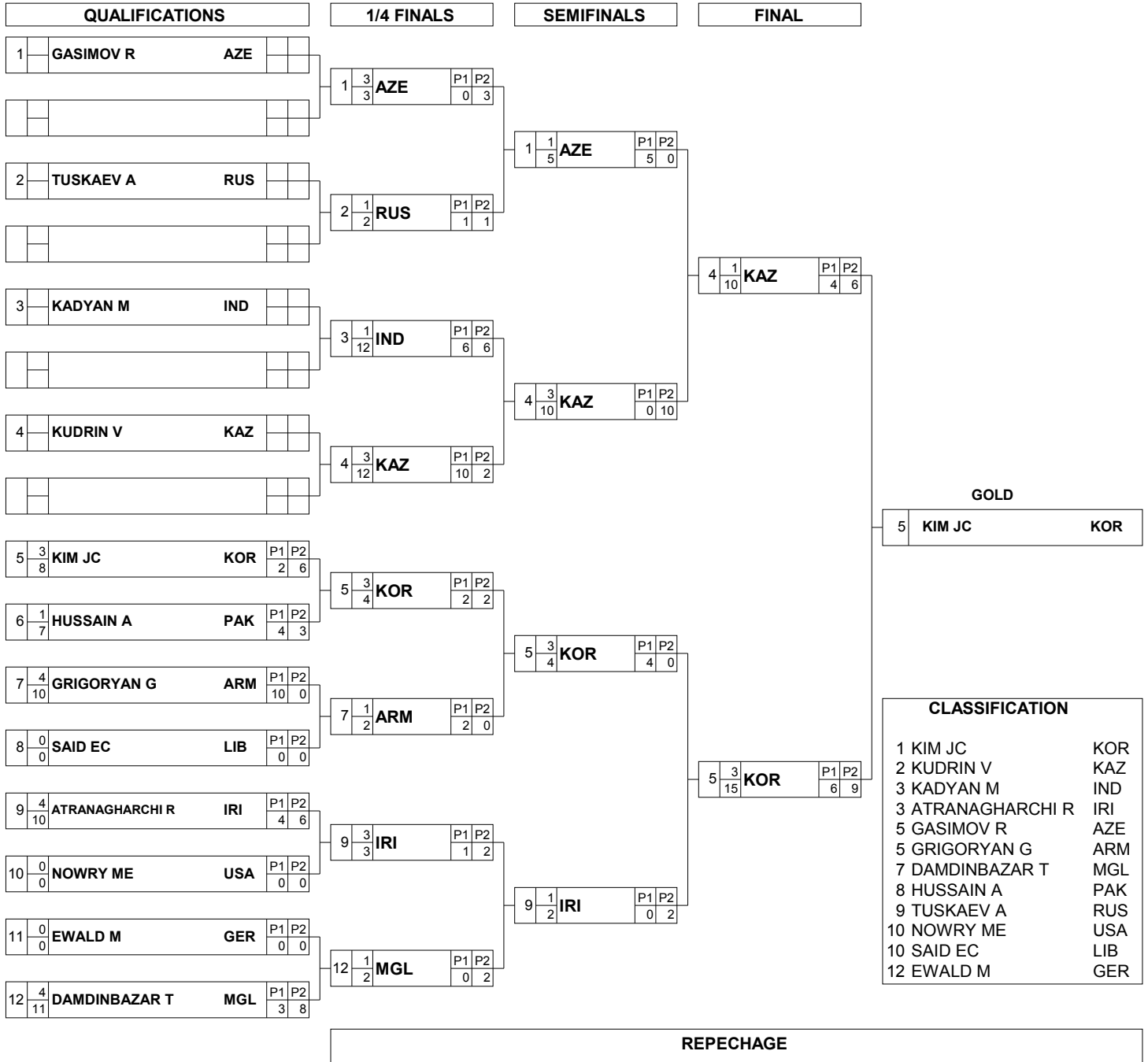

Competition Sheet

체급별 대진 정보



CLASSIFICATION		
1	KIM JC	KOR
2	KUDRIN V	KAZ
3	KADYAN M	IND
3	ATRANAGHARCHI R	IRI
5	GASIMOV R	AZE
5	GRIGORYAN G	ARM
7	DAMDINBAZAR T	MGL
8	HUSSAIN A	PAK
9	TUSKAEV A	RUS
10	NOWRY ME	USA
10	SAID EC	LIB
12	EWALD M	GER

REPECHAGE

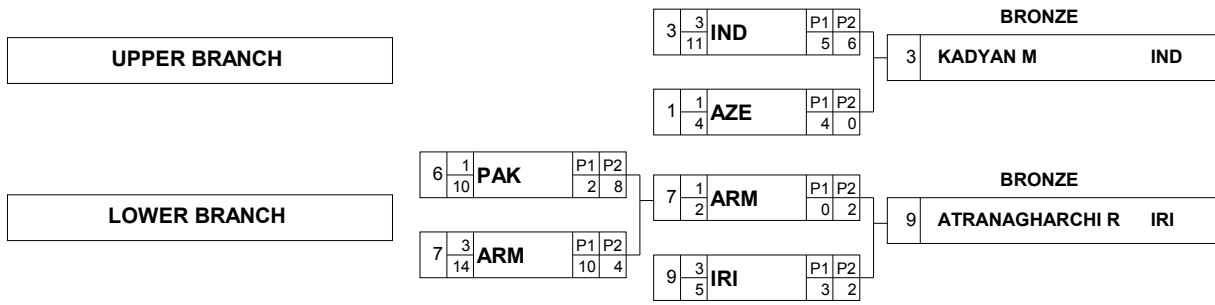



Competition Sheet
체급별 대진 정보

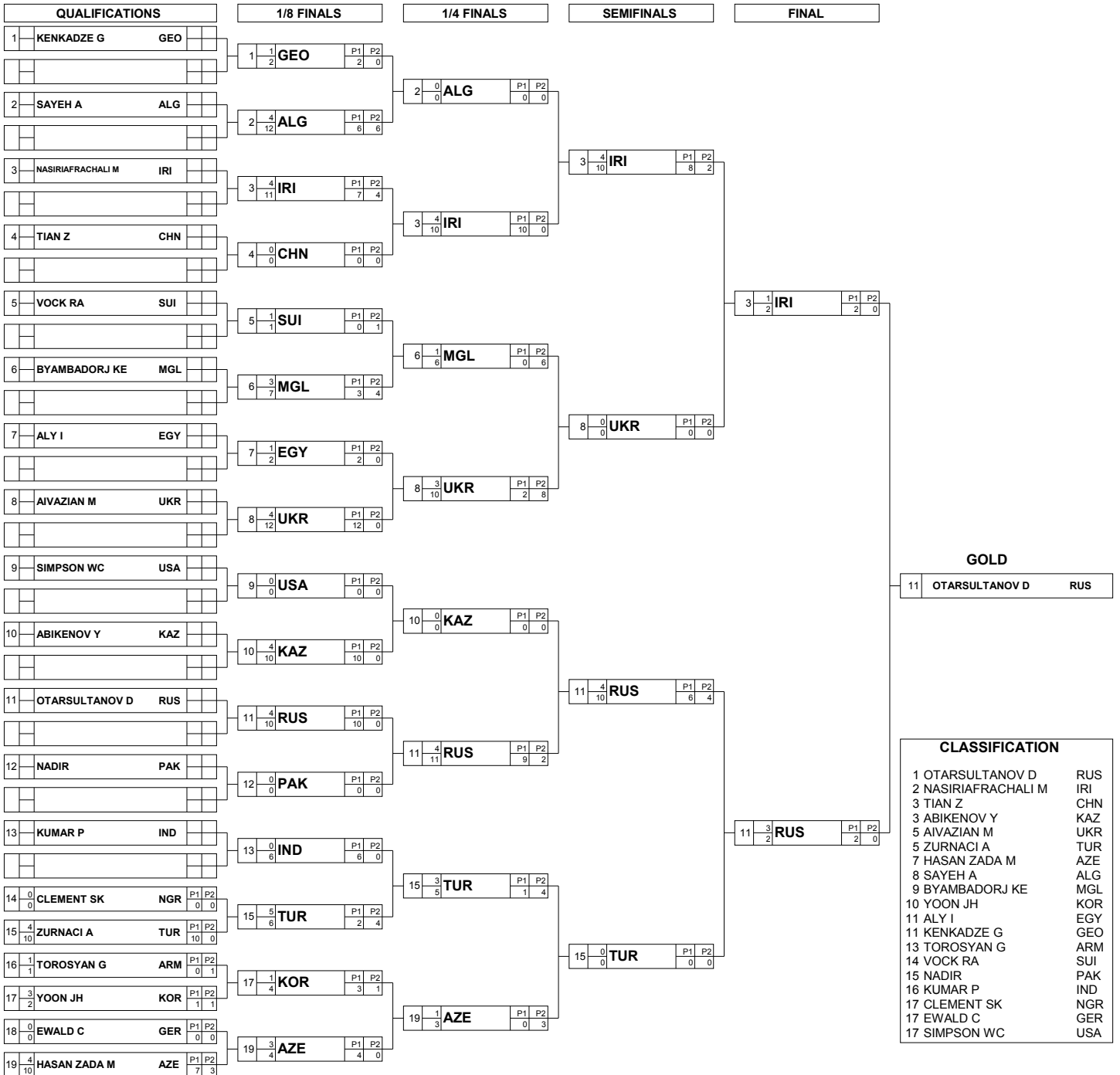



Competition Sheet

체급별 대진 정보



GOLD		
1	KVRBANALIEV M	RUS

CLASSIFICATION		
1	KVRBANALIEV M	RUS
2	HEYDARI M	IRI
3	MUSTAFAYEV A	AZE
4	SHAGAPULY A	KAZ
5	SHUPTAR V	UKR
6	BATCHULUUN B	MGL
7	AVETISYAN H	ARM
8	von OHLEN CL	USA
9	RAJNEESH R	IND
10	KIM JC	KOR
11	STATKIEWICZ R	POL
12	MOHAMED I	EGY
13	KIRAZ K	TUR
14	GEORGIEV I	MKD
15	HENKEL K	GER
16	JANELIDZE R	GEO

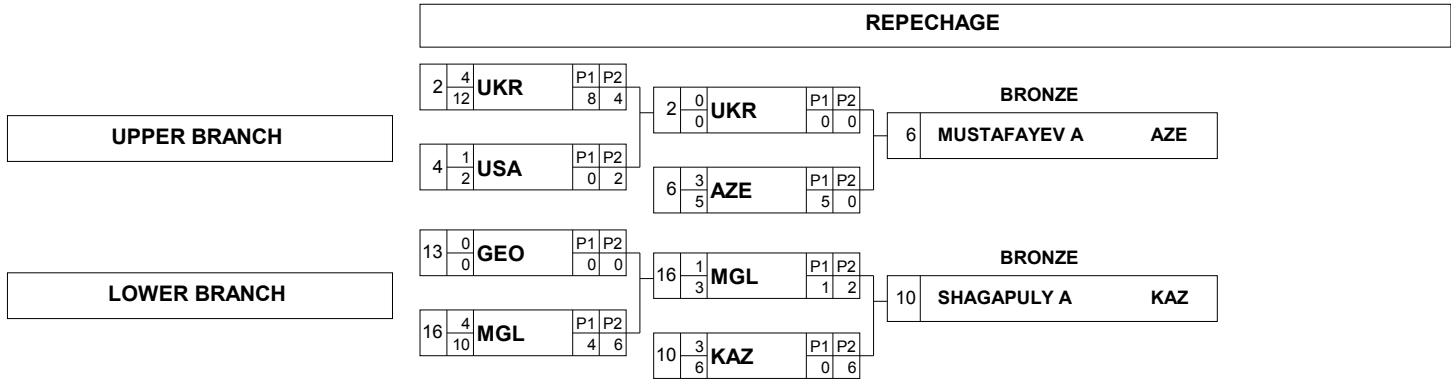



Competition Sheet

체급별 대진 정보

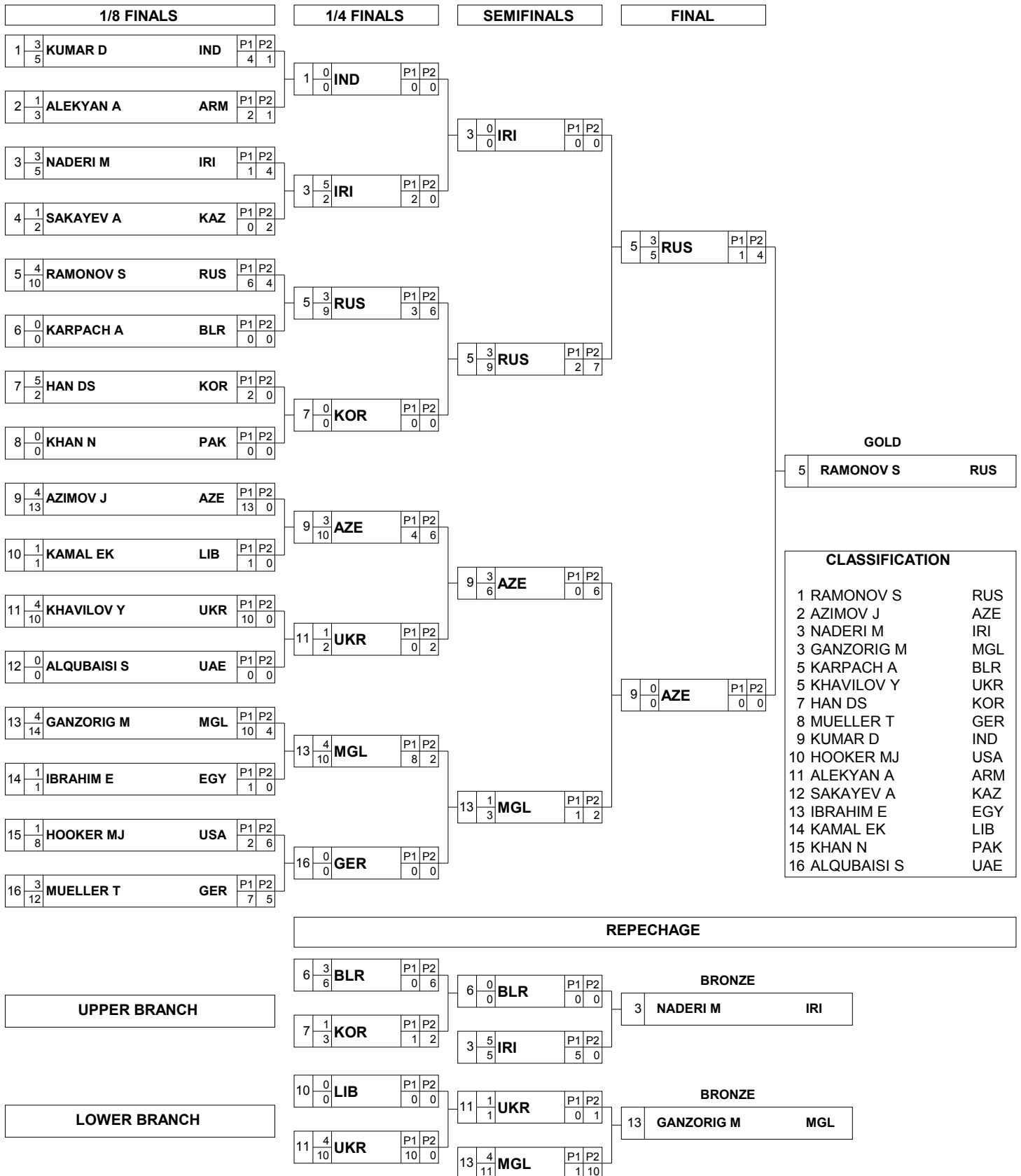



Competition Sheet
체급별 대진 정보

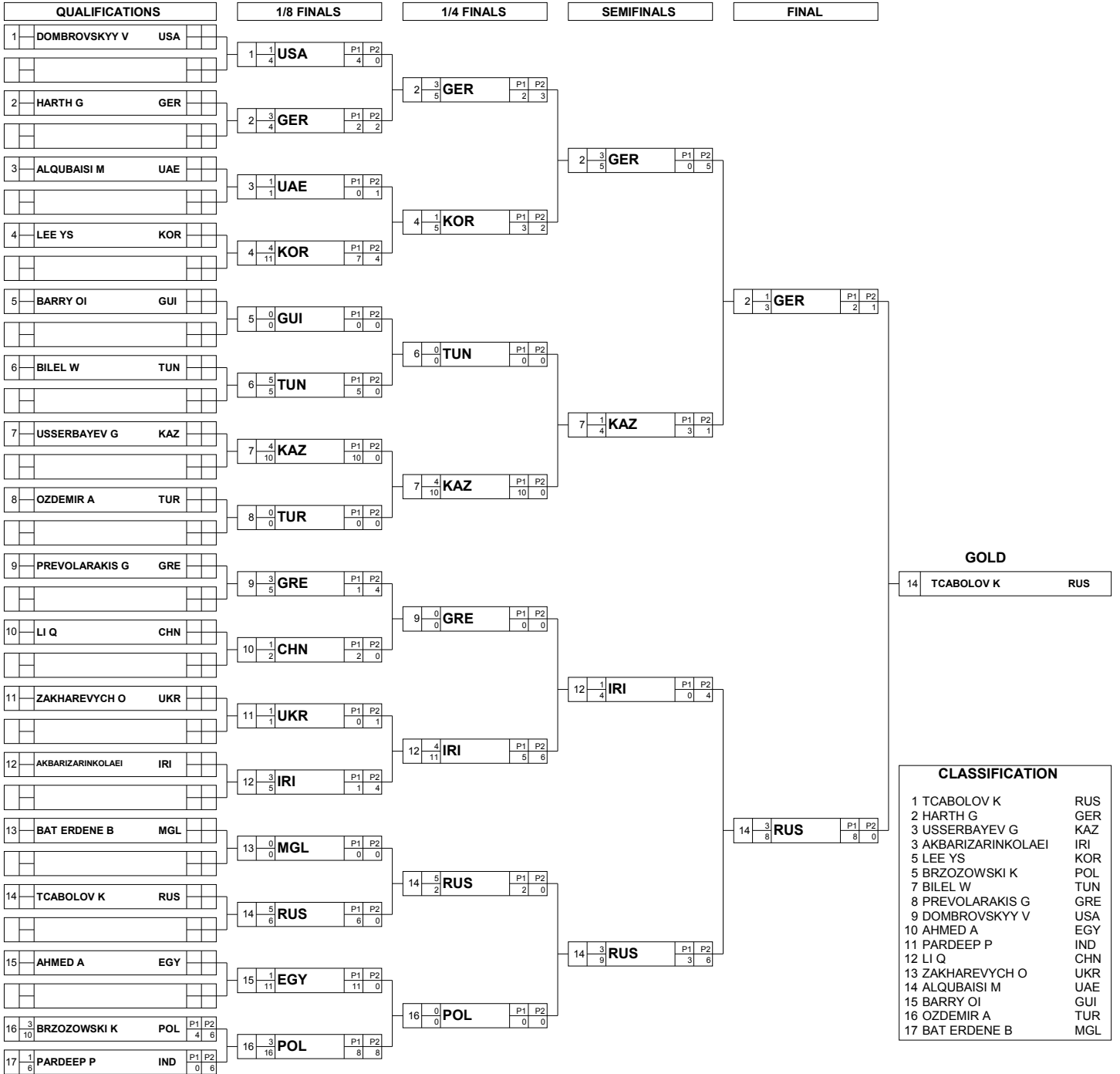

REPECHAGE

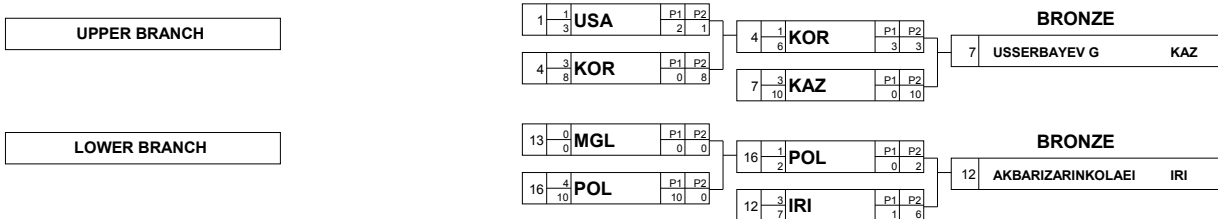



Competition Sheet

체급별 대진 정보

QUALIFICATIONS	1/8 FINALS	1/4 FINALS	SEMIFINALS	FINAL
1 KIM GU KOR	1 3/12 KOR P1:8 P2:4	1 0/4 KOR P1:2 P2:2		
2 YUSUBOV I AZE	2 1/4 AZE P1:2 P2:2			
3 ORGODOL U MGL	3 3/10 MGL P1:6 P2:4	3 5/2 MGL P1:0 P2:2	3 1/2 MGL P1:2 P2:0	
4 RIESEN ML SUI	4 1/4 SUI P1:4 P2:0			
5 OZOLINS OZOLS A LAT	5 5/9 LAT P1:7 P2:2	5 0/0 LAT P1:0 P2:0		
6 GHAILANI J UAE	6 0/0 UAE P1:0 P2:0			
7 KUDIAMAGOMEDOV S RUS	7 4/12 RUS P1:6 P2:6	7 3/10 RUS P1:6 P2:4	7 5/0 RUS P1:0 P2:0	
8 HARTH W GER	8 0/0 GER P1:0 P2:0	7 4/10 RUS P1:10 P2:0		
9 BILOTSERKIVSKIY O UKR	9 0/0 UKR P1:0 P2:0			
10 DAVLUMBAYEV A KAZ	10 3/8 KAZ P1:2 P2:6	10 4/13 KAZ P1:9 P2:4		
11 HUWATIBIEKE B CHN	11 4/11 CHN P1:1 P2:10	11 0/0 CHN P1:0 P2:0		
12 HELAL AM SYR	12 0/0 SYR P1:0 P2:0			
13 ABOU JAOUDE AA BRA	13 0/0 BRA P1:0 P2:0			
14 EBRAHIMIZIVLAEI M IRI	14 3/7 IRI P1:5 P2:2	14 3/6 IRI P1:4 P2:2		
15 HUSHTYN A BLR	15 1/2 BLR P1:0 P2:2			
16 TERRELL II VW USA	16 3/8 USA P1:4 P2:4	14 0/0 IRI P1:0 P2:0	14 3/12 IRI P1:0 P2:12	
17 MOHAMED M EGY	17 1/2 MOHAMED M EGY P1:2 P2:0			
18 NAIN K IND	18 5/4 NAIN K IND P1:4 P2:0	16 1/1 USA P1:1 P2:0		
19 MICHEL A LIB	19 0/0 MICHEL A LIB P1:0 P2:0			

GOLD
7 KUDIAMAGOMEDOV S RUS

CLASSIFICATION

1	KUDIAMAGOMEDOV S	RUS
2	EBRAHIMIZIVLAEI M	IRI
3	ORGODOL U	MGL
3	DAVLUMBAYEV A	KAZ
5	HARTH W	GER
5	HUSHTYN A	BLR
7	TERRELL II VW	USA
8	NAIN K	IND
9	OZOLINS OZOLS A	LAT
10	HUWATIBIEKE B	CHN
11	KIM GU	KOR
12	RIESEN ML	SUI
13	YUSUBOV I	AZE
14	MOHAMED M	EGY
15	ABOU JAOUDE AA	BRA
16	MICHEL A	LIB
17	BILOTSERKIVSKIY O	UKR
18	GHAILANI J	UAE
19	HELAL AM	SYR

REPECHAGE

UPPER BRANCH	LOWER BRANCH
8 4/11 GER P1:11 P2:0	15 4/13 BLR P1:3 P2:10
5 0/0 LAT P1:0 P2:0	13 1/2 BRA P1:2 P2:0
8 1/1 GER P1:0 P2:1	15 4/11 BLR P1:8 P2:3
3 3/3 MGL P1:2 P2:1	16 1/1 USA P1:1 P2:0
3 ORGODOL U MGL	15 1/6 BLR P1:4 P2:2
	10 3/10 KAZ P1:4 P2:6
	10 DAVLUMBAYEV A KAZ



Competition Sheet

체급별 대진 정보

